

Gain and Attenuation Volume Controller IC

One Set of Stereo Input, Low voltage

Gain and Attenuation 15~-79dB

FEATURES

- Operation range: 2.7V~6.5V
- Low power consumption
- Gain / Attenuation: 15 to -79dB
- +1dB/step, -1dB/step and -10dB/step are controlled independently
- I²C interface
- Housed in 8 pin SOP package

APPLICATIONS

- Multimedia system
- Hi-Fi audio system
- MP3, PDA

DESCRIPTION

The MS6257 is the stereo audio volume controller IC. It uses CMOS technology specially for the low voltage application with low noise, rail-to-rail output. The MS6257 provide an I²C control interface with gain / attenuation range of 15dB to -79dB. The gain and attenuation, +1dB/step, -1dB/step and -10dB/step are controlled independently. The initial condition is set to be maximum attenuation -79dB (-70dB + -9dB), gain 0dB and mute on mode when the power is up.

BLOCK DIAGRAM

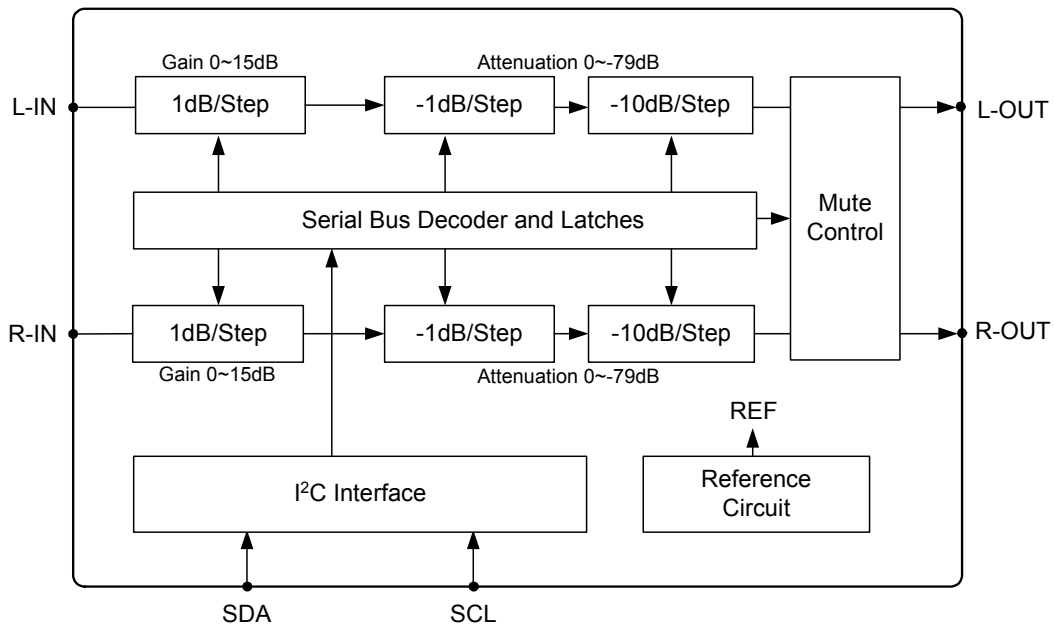

PIN CONFIGURATION

Symbol	Pin	Description
L-IN	1	Left channel input
L-OUT	2	Left channel output
V _{SS}	3	Ground
SDA	4	I ² C data input
SCL	5	I ² C clock input
V _{DD}	6	Positive supply voltage
R-OUT	7	Right channel output
R-IN	8	Right channel input

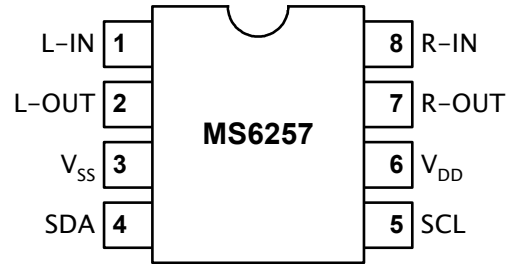

ORDERING INFORMATION

Package	Part number	Packaging Marking	Transport Media
8-Pin SOP (lead free)	MS6257GTR	MS6257G	2.5k Units Tape and Reel
8-Pin SOP (lead free)	MS6257GU	MS6257G	100 Units Tube

RoHS Compliance

ABSOLUTE MAXIMUM RATINGS

Symbol	Parameter	Rating	Unit
V _{DD}	Supply Voltage	6.5	V
V _{ESD}	Electrostatic Handling	-4500 to 4500	V
T _{STG}	Storage Temperature Range	-65 to 150	°C
T _A	Operating Ambient Temperature Range	-40 to 85	°C
T _J	Maximum Junction Temperature	150	°C
T _S	Soldering Temperature, 10 seconds	260	°C
R _{THJA}	Thermal Resistance from Junction to Ambient in Free Air SOP8	210	°C/W

OPERATING RATINGS

Symbol	Parameter	Min	Typ	Max	Unit
V _{DD}	Supply Voltage	2.7	-	6.5	V

5V ELECTRICAL CHARACTERISTICS

($V_{DD}=5.0V$, $V_{SS}=0V$, Attenuation=0dB, Gain=0dB, $f=1KHz$, $V_O=0dBV$; unless otherwise specified)

Symbol	Parameter	Conditions	Min	Typ	Max	Unit
DC Characteristics						
I_Q	Quiescent current		-	3.1	3.5	mA
A_{GA}	Gain/Attenuation	Max gain	-	15	-	dB
		Max attenuation	-	-79	-	dB
A_{STEP}	Gain/Attenuation step		-	1	-	dB
E_{GA}	Gain/Attenuation step error		-	0.3	-	dB
CS	Channel separation		120	130	-	dB
MUTE	Mute Attenuation	$V_{in}=0dBV$	-	85	-	dB
R_{in}	Input Impedance		18	20	-	$k\Omega$
R_{out}	Output Impedance		-	50	100	Ω
AC Characteristics						
V_O	Maximum output voltage swing	$(THD+N)/S < 0.1\%$	-	4.8	-	Vpp
THD+N	Total harmonic distortion plus noise		-	-68	-63	dB
S/N	Signal-to-noise ratio	$V_O=4.5V_{pp}$	95	100	-	dB
Bus Characteristics						
V_{IH}	Bus high input level		-	-	$0.7V_{DD}$	V
V_{IL}	Bus low input level		$0.3V_{DD}$	-	-	V

3.3V ELECTRICAL CHARACTERISTICS

($V_{DD}=3.3V$, $V_{SS}=0V$, Attenuation=0dB, Gain=0dB, $f=1KHz$, $V_O=-3dBV$; unless otherwise specified)

Symbol	Parameter	Conditions	Min	Typ	Max	Unit
DC Characteristics						
I_Q	Quiescent current		-	2.8	3.3	mA
CS	Channel separation		90	110	-	dB
MUTE	Mute Attenuation	$V_{in}=-3dBV$	-	80	-	dB
AC Characteristics						
V_O	Maximum output voltage swing	$(THD+N)/S < 0.1\%$	-	3	-	Vpp
THD+N	Total harmonic distortion plus noise		-	-63	-58	dB
S/N	Signal-to-noise ratio		85	90	-	dB

2.7V ELECTRICAL CHARACTERISTICS

($V_{DD}=2.7V$, $V_{SS}=0V$, Attenuation=0dB, Gain=0dB, $f=1KHz$, $V_O=-3dBV$; unless otherwise specified)

Symbol	Parameter	Conditions	Min	Typ	Max	Unit
DC Characteristics						
I_Q	Quiescent current		-	2.5	2.9	mA
CS	Channel separation		95	105	-	dB
MUTE	Mute Attenuation	$V_{in}=-3dBV$	-	80	-	dB
AC Characteristics						
V_o	Maximum output voltage swing	$(THD+N)/S < 0.3\%$	-	2	-	V_{pp}
THD+N	Total harmonic distortion plus noise		-	-60	-55	dB
S/N	Signal-to-noise ratio		85	90	-	dB

TYPICAL PERFORMANCE CHARACTERISTICS

($T_a=25^\circ C$; unless otherwise specified)

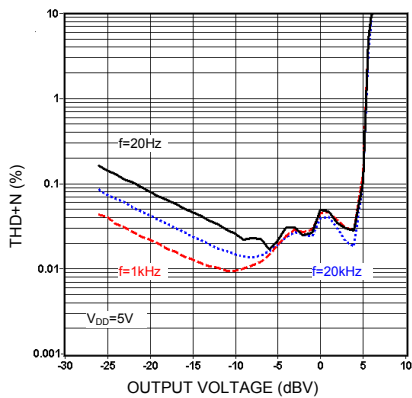

THD+N vs. output voltage

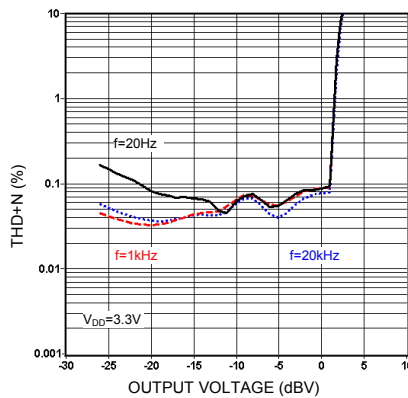

THD+N vs. output voltage

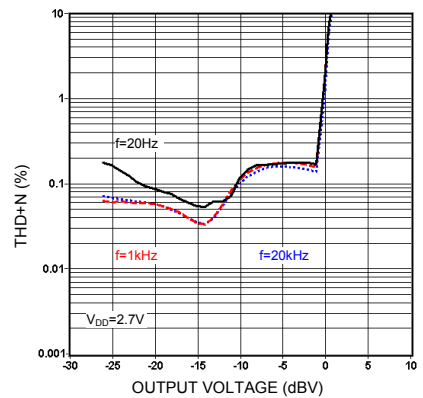

THD+N vs. output voltage

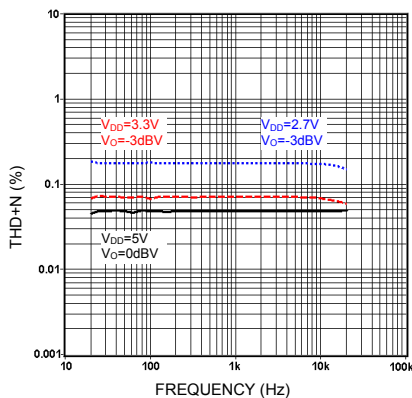

THD+N vs. frequency

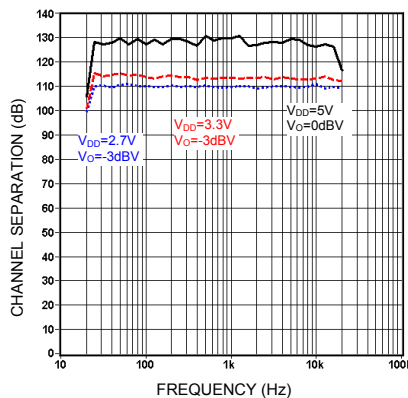

Channel separation vs. frequency

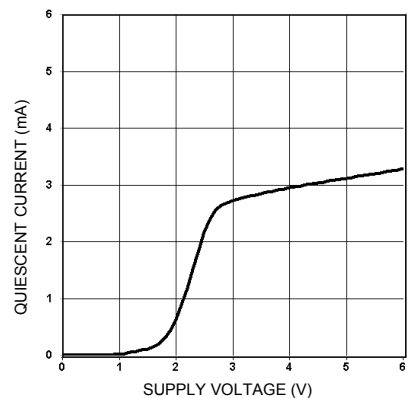

Quiescent current vs. supply voltage

I²C BUS DESCRIPTION

Start and stop conditions

A start condition is activated when the SCL is set to HIGH and SDA shifts from HIGH to LOW state. The stop condition is activated when SCL is set to HIGH and SDA shifts from LOW to HIGH state. Please refer to the timing diagram below.

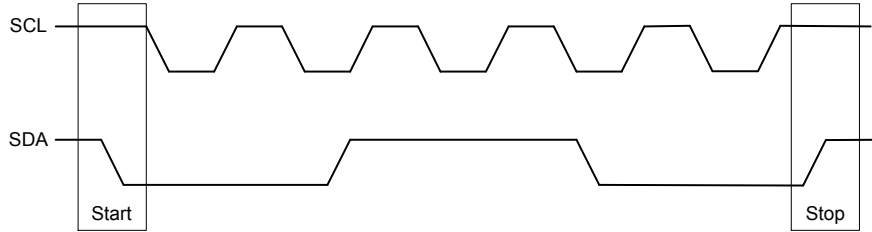

SCL : Serial Clock Line, SDA : Serial Data Line

Data validity

A data on the SDA line is considered valid and stable only when the SCL signal is in HIGH state. The HIGH and LOW states of the SDA line can only change when the SCL signal is LOW. Please refer to the figure below.

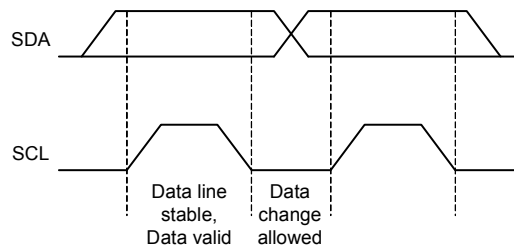

Byte format

Every byte transmitted to the SDA line consists of 8 bits. Each byte must be followed by an acknowledge bit. The MSB is transmitted first.

Acknowledge

During the Acknowledge clock pulse, the master (up) put a resistive HIGH level on the SDA line. The peripheral (audio processor) that acknowledges has to pull-down (LOW) the SDA line during the Acknowledge clock pulse so that the SDA line is in a stable LOW state during this clock pulse. Please refer to the diagram below.

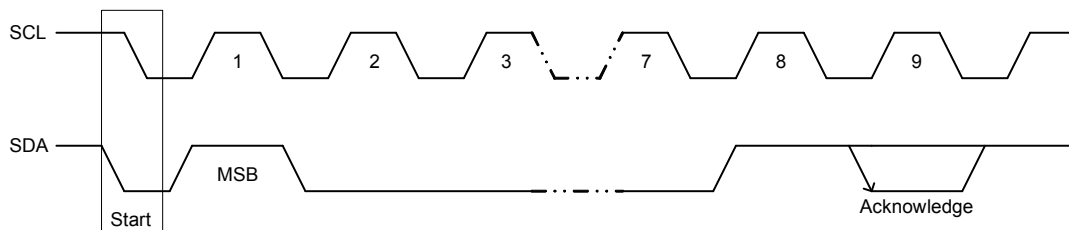

The audio processor that has been addressed has to generate an Acknowledge after receiving each byte, otherwise, the SDA line will remain at the HIGH level during the ninth (9th) clock pulse. In this case, the master transmitter can generate the STOP information in order to abort the transfer.

Timing of SDA and SCL bus lines

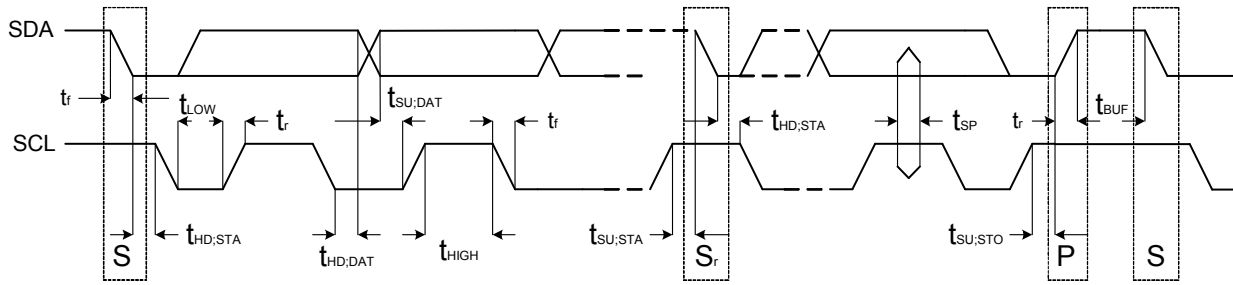

Standard mode

Symbol	Parameter	Min	Max	Unit
f_{SCL}	SCL clock frequency	0	100	kHz
$t_{HD:STA}$	Hold time (repeated) START condition. After this period, the first clock pulse is generated	4.0	-	us
t_{LOW}	LOW period of the SCL clock	4.7	-	us
t_{HIGH}	HIGH period of the SCL clock	4.0	-	us
$t_{SU:STA}$	Set-up time for a repeated START condition	4.7	-	us
$t_{HD:DAT}$	Data hold time: For I ² C-bus devices	0	3.45	us
$t_{SU:DAT}$	Data-set-up time	250	-	ns
t_r	Rise time of both SDA and SCL signals	-	1000	ns
t_f	Fall time of both SDA and SCL signals	-	300	ns
$t_{SU:STO}$	Set-up time for STOP condition	4.0	-	us
t_{BUF}	Bus free time between a STOP and START condition	4.7	-	us
C_b	Capacitive load for each bus line	-	400	pF
V_{nL}	Noise margin at the LOW level for each connected device (including hysteresis)	$0.1V_{DD}$	-	V
V_{nH}	Noise margin at the HIGH level for each connected device (including hysteresis)	$0.2V_{DD}$	-	V

BUS INTERFACE

Data are transmitted to and from the MCU to the MS6257 via the SDA and SCL. The SDA and SCL make up the BUS interface. It should be noted that pull-up resistors must be connected to the positive supply voltage.

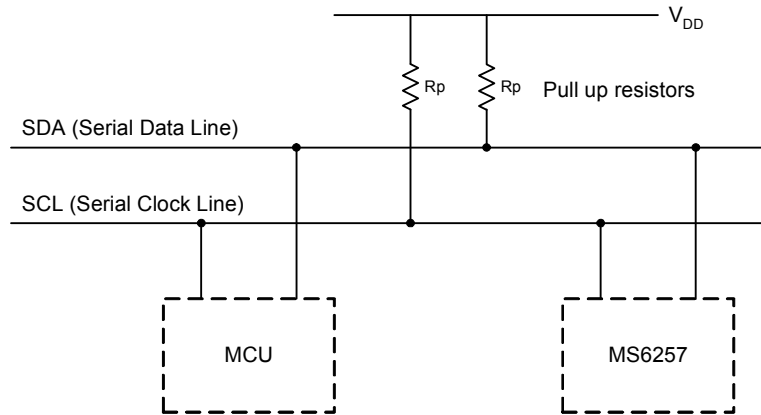

Interface protocol

The format consists of the following

- A START condition
- A chip address byte including the MS6257 address. (7bits)
- The 8th bit of the byte must be “0”.(write=0, read=1)
- MS6257 must always acknowledge the end of each transmitted byte.
- A data sequence (N-bytes + Acknowledge)
- A STOP condition

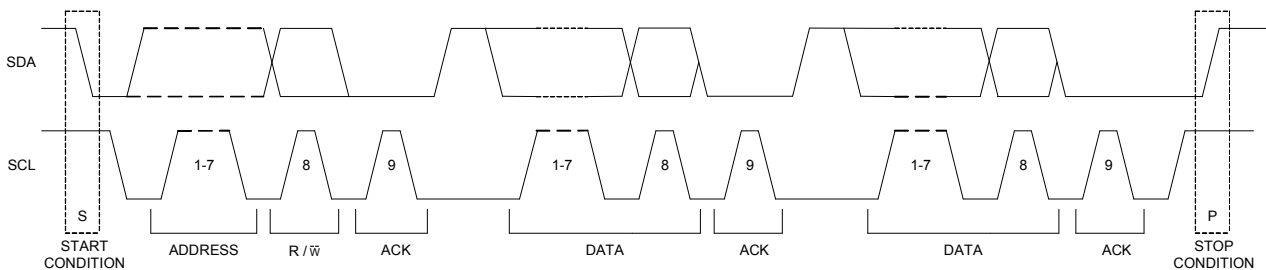

Protocol Address

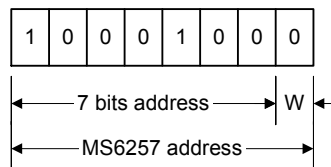

Data bytes description

Function bits								
MSB							LSB	Function description
1	1	1	1	1	1	1	1	Function OFF (-79dB)
1	1	0	1	A3	A2	A1	A0	2-channel, -1dB/step
1	1	1	0	0	B2	B1	B0	2-channel, -10dB/step
1	0	1	0	A3	A2	A1	A0	Left channel, -1dB/step
1	0	1	1	0	B2	B1	B0	Left channel, -10dB/step
0	0	1	0	A3	A2	A1	A0	Right channel, -1dB/step
0	0	1	1	0	B2	B1	B0	Right channel, -10dB/step
1	1	0	0	C3	C2	C1	C0	2-channel, +1dB/step
0	1	1	0	C3	C2	C1	C0	Left channel, +1dB/step
0	1	0	1	C3	C2	C1	C0	Right channel, +1dB/step
0	1	1	1	1	0	0	M	2-channel, MUTE When M=1, MUTE=ON When M=0, MUTE=OFF

Gain / Attenuation bits						
A3	A2	A1	A0	Attenuation (dB)		Gain (dB)
-	B2	B1	B0	A	B	C
C3	C2	C1	C0			
0	0	0	0	0	0	0
0	0	0	1	-1	-10	+1
0	0	1	0	-2	-20	+2
0	0	1	1	-3	-30	+3
0	1	0	0	-4	-40	+4
0	1	0	1	-5	-50	+5
0	1	1	0	-6	-60	+6
0	1	1	1	-7	-70	+7
1	0	0	0	-8	-	+8
1	0	0	1	-9	-	+9
1	0	1	0	-	-	+10
1	0	1	1	-	-	+11
1	1	0	0	-	-	+12
1	1	0	1	-	-	+13
1	1	1	0	-	-	+14
1	1	1	1	-	-	+15

1. Attenuation bit, Ax = -1dB/step, Bx = -10dB/step
2. Gain bit, Cx = +1dB/step
3. Total gain / attenuation equal Ax + Bx + Cx.

An example of the volume control. (Volume = Ax + Bx + Cx)

Set two channels at 0dB. (Ax + Bx + Cx = 0dB + 0dB + 0dB)

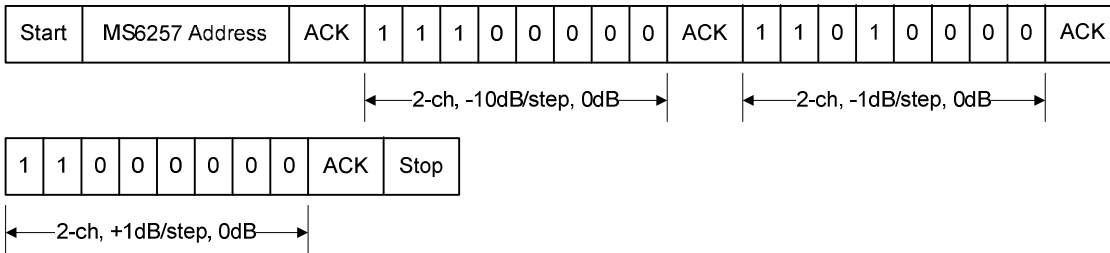

next, the volume changes from 0dB to -9dB. (Ax + Bx + Cx = -9dB + 0dB + 0dB)

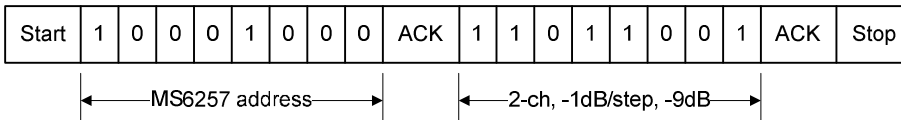

next, the volume changes from -9dB to -19dB. (Ax + Bx + Cx = -9dB + -10dB + 0dB)

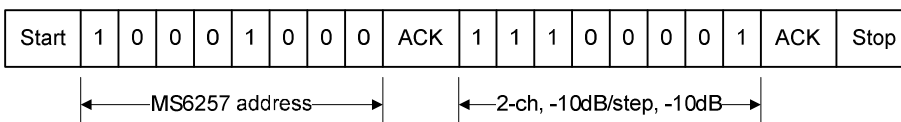

next, the volume changes from -19dB to -20dB. (Ax + Bx + Cx = 0dB + -20dB + 0dB)

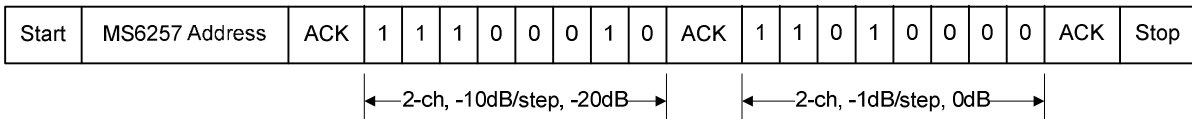

next, the volume changes from -20dB to -14dB. (Ax + Bx + Cx = 0dB + -20dB + 6dB)

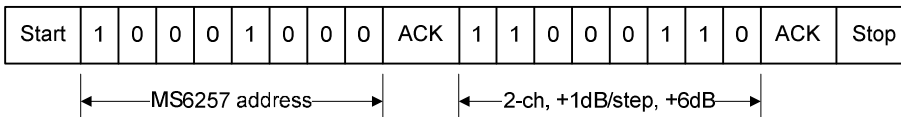

next, the volume changes from -14dB to +6dB. (Ax + Bx + Cx = 0dB + 0dB + 6dB)

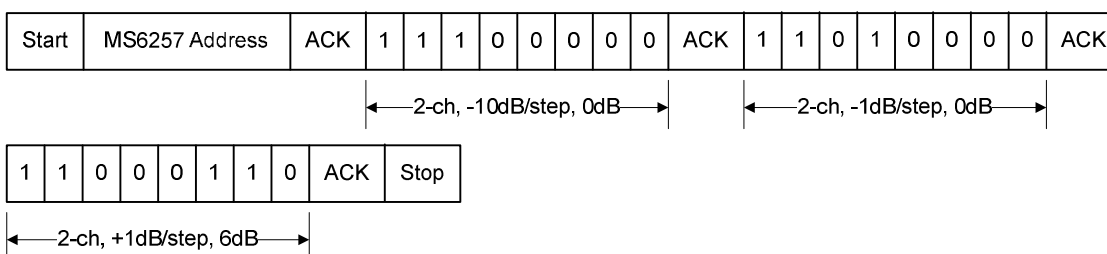

Note: We suggest the gain is set as the power is up. For example, set and fix the gain +10dB, the volume range will be controlled from +10dB to -69dB.

APPLICATION INFORMATION

Basic application example

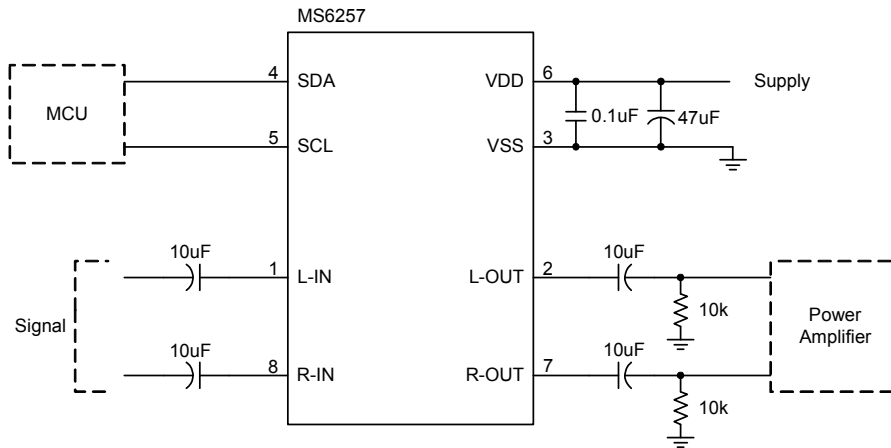

Basic application flow chart

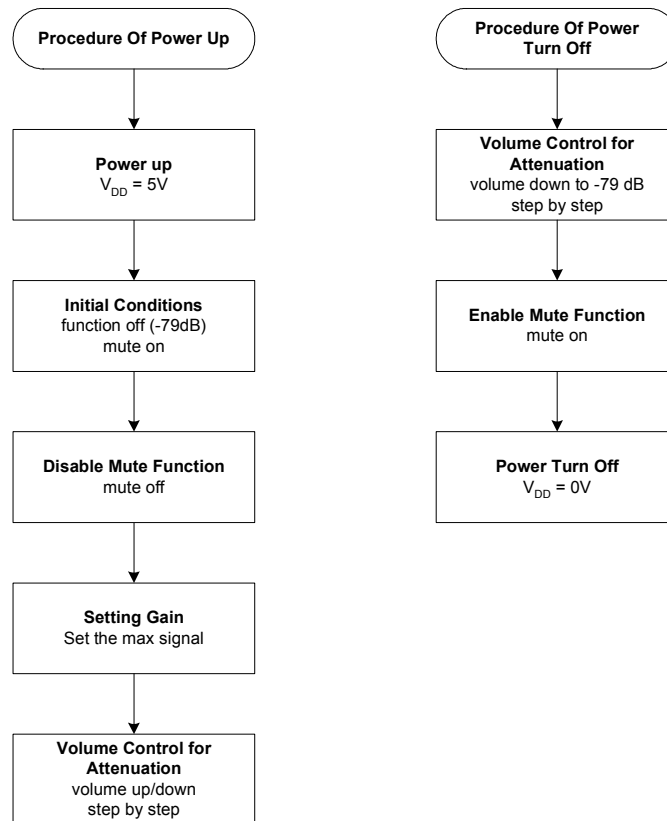

1. The initial condition is attenuation -79dB , gain 0dB and mute on when power is up.

EXTERNAL DIMENSIONS

SOP8 package

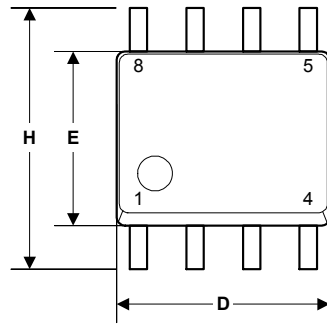

Symbol	Dimension in mm		Dimension in inch	
	Min	Max	Min	Max
A	1.35	1.75	0.0532	0.0688
A1	0.10	0.25	0.0040	0.0098
B	0.33	0.51	0.013	0.020
C	0.19	0.25	0.0075	0.0098
D	4.80	5.00	0.1890	0.1968
H	5.80	6.20	0.2284	0.2440
E	3.80	4.00	0.1497	0.1574
e	1.27 BSC		0.050 BSC	
L	0.40	1.27	0.016	0.050

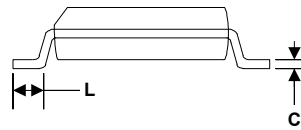
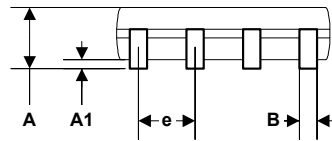

TAPE AND REEL (Unit : mm)

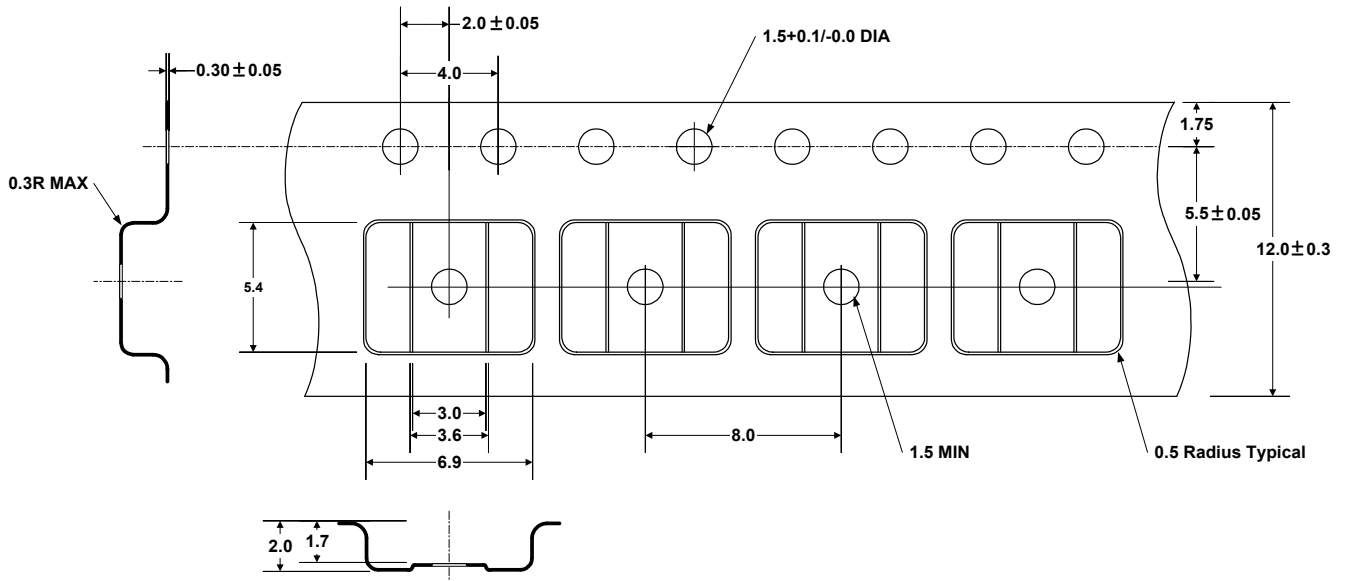

DEMO BOARD

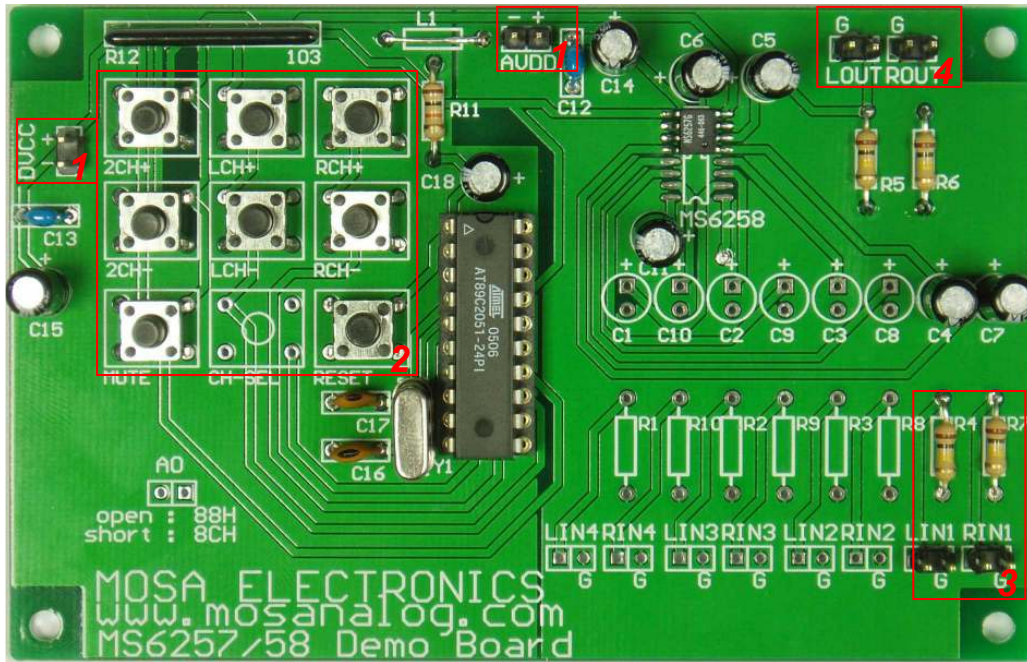

Label 1: Supply Voltage

The AVDD and DVDD should be the same supply voltage, the supply range is 2.7~6.5 VDC.

Label 2: Control Switch

2-CH+ : The volume-up switch for stereo channel

The volume increase by +1dB as the switch is pressed once, the maximum value is up to +15dB.

The default value is 0dB on initial status.

L-channel and R-channel are active synchronic.

2-CH- : The volume-down switch for stereo channel

The volume decrease by -1dB as the switch is pressed once, the minimum value is up to -79dB.

L-channel and R-channel are active synchronic.

LCH+ : The volume-up switch for left channel

The volume increase by +1dB as the switch is pressed once, the maximum value is up to +15dB.

LCH- : The volume-down switch for left channel

The volume decrease by -1dB as the switch is pressed once, the minimum value is up to -79dB.

RCH+ : The volume-up switch for right channel

The volume increase by +1dB as the switch is pressed once, the maximum value is up to +15dB.

RCH- : The volume-down switch for right channel

The volume decrease by -1dB as the switch is pressed once, the minimum value is up to -79dB.

MUTE : Press the switch once to enter mute-on or mute-off.

The default status is mute-off on initial status.

RESET : Reset MCU controller, the system will be loaded default value.

Label 3: Input section

Please input stereo audio signal, as music or sine wave.

Label 4: Output section

Please connected to a post-power-amplifier, as stereo speaker.

Circuit

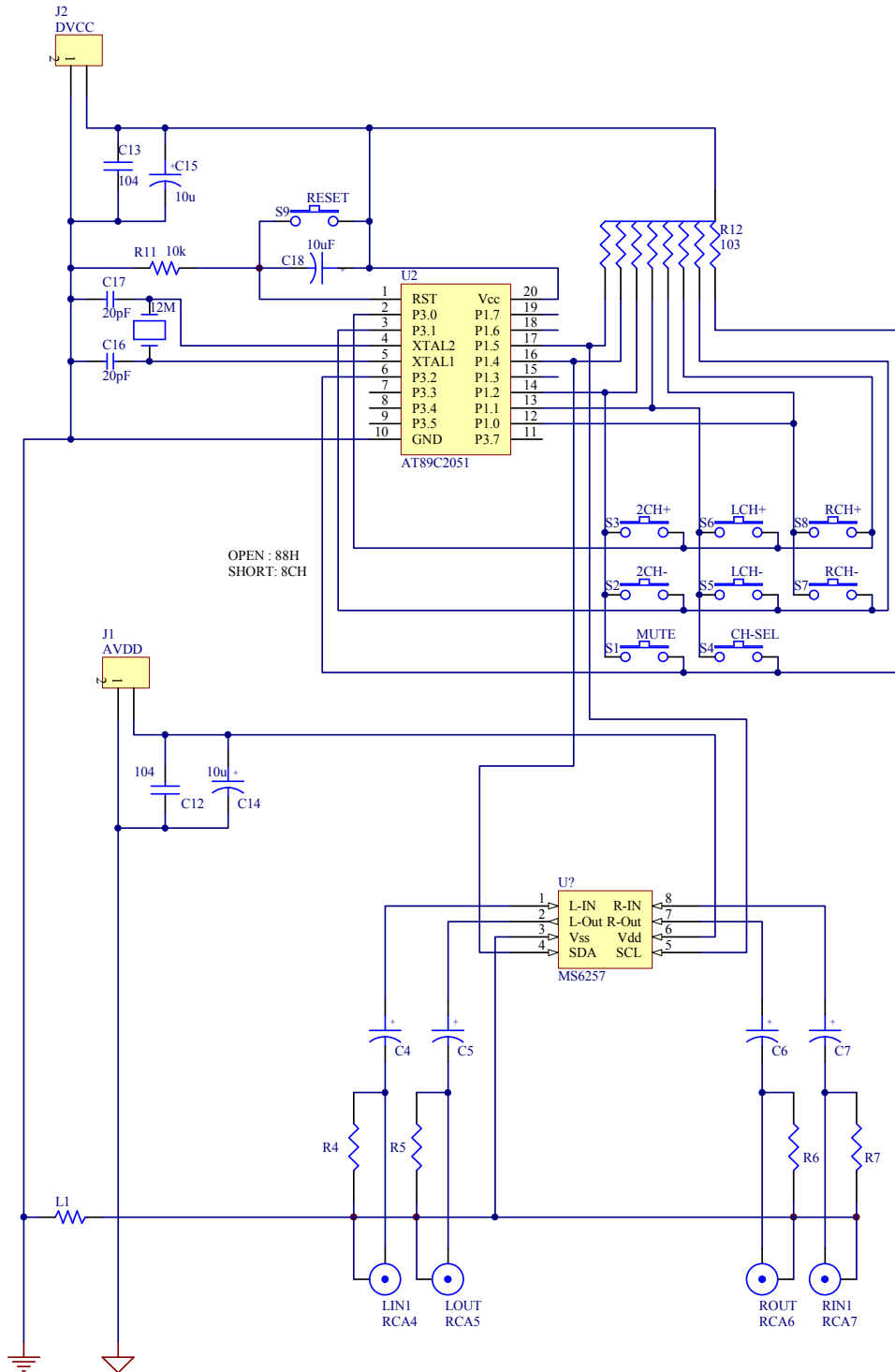

Demo board(IR Controller)

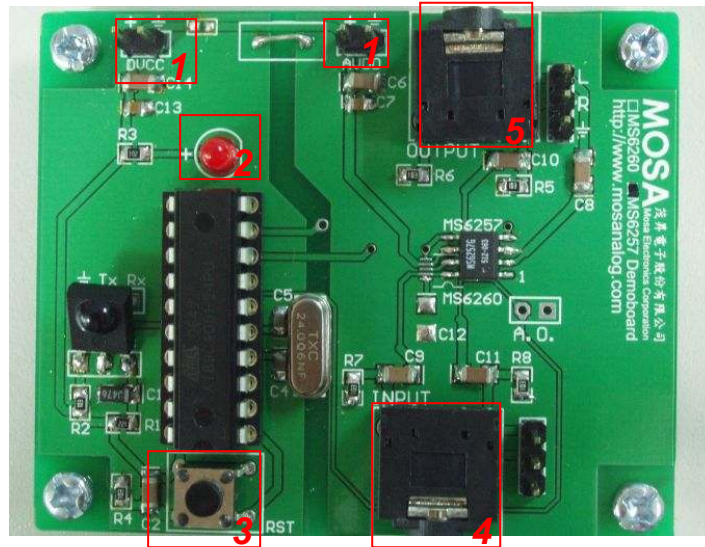

Function description

Label 1: Supply Input

Supply voltage range is 2.7V to 6.5V.

Label 2: LED Indicator

The LEDs indicate the chip status and IR received status. It is red-dark blink once when the MCU has received the function code correctly.

Label 3: Reset

All I/O pins are reset to default values.

Label 4: Signal Input

There are four stereo inputs in the section. Please input stereo audio signal, as music or sine wave.

Label 5: DAC output

Connected to a post-power-amplifier, as active speaker.

IR Controller

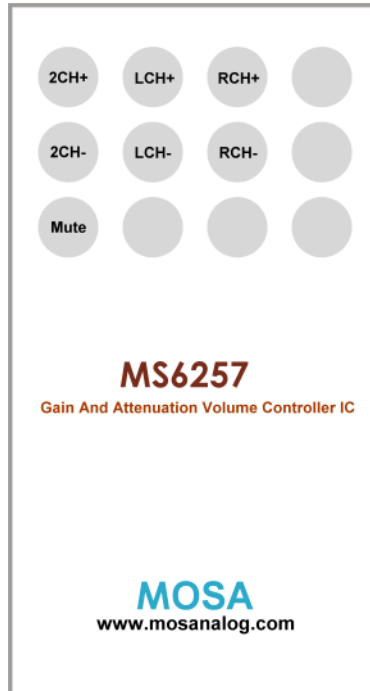

- 2-CH+ :** The volume-up switch for stereo channel
The volume increase by +1dB as the switch is pressed once, the maximum value is up to +15dB.
The default value is 0dB on initial status.
L-channel and R-channel are active synchronic.
- 2-CH- :** The volume-down switch for stereo channel
The volume decrease by -1dB as the switch is pressed once, the minimum value is up to -79dB.
L-channel and R-channel are active synchronic.
- LCH+ :** The volume-up switch for left channel
The volume increase by +1dB as the switch is pressed once, the maximum value is up to +15dB.
- LCH- :** The volume-down switch for left channel
The volume decrease by -1dB as the switch is pressed once, the minimum value is up to -79dB.
- RCH+ :** The volume-up switch for right channel
The volume increase by +1dB as the switch is pressed once, the maximum value is up to +15dB.
- RCH- :** The volume-down switch for right channel
The volume decrease by -1dB as the switch is pressed once, the minimum value is up to -79dB.
- MUTE :** Press the switch once to enter mute-on or mute-off.
The default status is mute-off on initial status.

Circuit

